

SDW-MP Series

MPPT Solar Charge Controller

USER MANUAL

Compatible Models:

SDW-MP10A

SDW-MP15A

SDW-MP20A

High Technology Create A Better Life!

Preface

Thank you very much for selecting our product!

This manual offers important information and suggestions with respect to installation, use and troubleshooting, etc.

Please read this manual carefully before using the product and pay attention to the safety recommendations in it.

Contents of this manual are subject to change without notice, and updates will be added in the new version of the user manual.

For ease of reference, please take good care of this manual

Contents



1. Products Introduction.....	4
1.1 Product Description.....	4
1.2 Main Features.....	4
1.3 Technical Parameters.....	5
1.4 Dimension.....	6
1.5 Protective function.....	7-8
2. Instructions.....	9
2.1 Panel Introduction.....	9
2.2 LED Indicators.....	9-10
2.3 Charge Description.....	10-13
2.4 Discharge Description.....	14-15
3. Installation.....	15
3.1 Fix the controller.....	15
3.2 Connection method.....	15-17
3.3 Connection step.....	17
4.Trouble Shooting.....	18
5.I R Remote Control.....	19
5.1 Diagram.....	19
5.2 Operation of remote control.....	19-21
5.3 Introduction for different controller models.....	22-24
5.4 Real-Time Data.....	24
5.5 System Setting.....	24-25
5.6 Additional function.....	25
5.7 Appendix.....	25-26
6.Warranty.....	27

Products Introduction

1.1 Product Description

SDW-MP series MPPT solar controller, ,Using the maximum power point tracking technology, real-time tracking of the best working point of solar panel,With maximum power from PV to charge the battery,PV charge efficiency can be significantly improved. Because the product can be used for charging current, the voltage can be accurately controlled. Therefore very suitable for the lithium battery charging.Mainly used for small off grid solar power system.

Multiple operation modes are provided including automatic mode, light-control mode, and manual mode. A test mode is also available for engineering installation.

1.2 Main Features

- 1,MPPT technology.Compatible with AGM GEL,LI etc battery
- 2,Automatic 12v/24v Detection
- 3,Peak conversion efficiency up to 98%
- 4,High tracking efficiency of 99%
- 5,Waterproof IP67
- 6,Over load capability 110% normal running,125% 1min,150% 20s
- 7,Aluminum housing for better cooling
- 8,-40°C~+55°C Wide temperature range

1.3 Technical Parameters

	Name	MPPT Solar charge controller		
	Model	SDW-MP10A	SDW-MP15A	SDW-MP20A
Charge	Charge mode	MPPT(maximum power point tracking)		
	Battery Type	Lead acid / Gel / LI / DIY		
	Max Pv Voltage	100v		
	Current	10A	15A	20A
Discharge	Discharge mode	Switch control		
	Load type	12/24v auto		
	Output Voltage	Battery Voltage		
	Output Current	10A	15A	10A
Others	Typical Efficiency	>98%		
	Temperature	-40~55℃		
	Self-consumption	≤14mA		
Size	Cover Size	110×92×29mm	120×92×29mm	130×92×29mm
	Waterproof Grade	IP67		
	Net weight	510g	550g	590g
	Work temperature	-40~+55℃		

1.4 Dimension

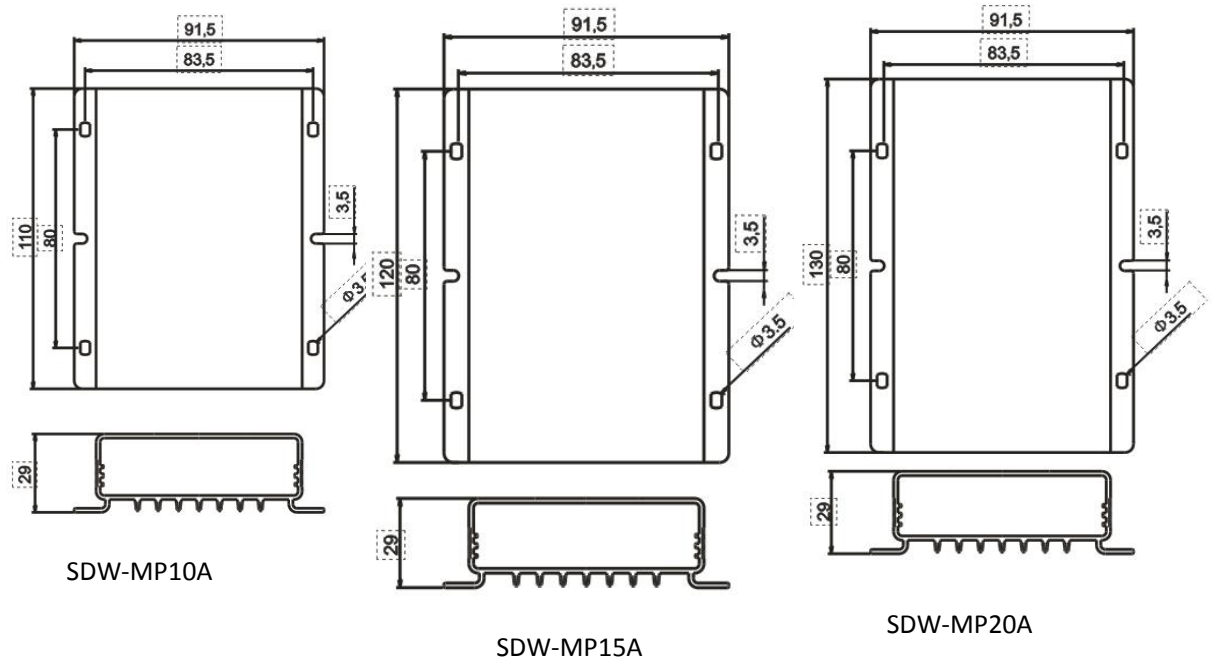
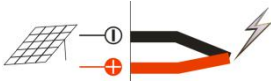











Figure 1.4 Product appearance

1.5 Protective Function

	<p><u>PV short circuit</u>: If the PV array input of a short circuit , the controller will disconnect the associated circuitry; When the short circuit condition clears , the charge will automatically recovery</p>
	<p><u>PV current is too high</u>: PV array input of the current is too high , resulting in over-temperature controller , the controller will automatically cut off the PV input.</p>
	<p><u>Load Fault</u>: before the load is turned on, Detects the load if there is a short circuit or open circuit failure,If there is a fault, controller protected itself automatically, and it will detect every once in a while whether the load fault has been ruled out automatically.If the fault persists more than 7 minutes,the controller will not turn on the load today,until the next day to try again or technical personnel to troubleshoot.</p>
	<p><u>Over Power Protection</u>:When the load power exceeds the rated power more than 15%,controller will limit the maximum output power.</p>
	<p><u>Overload Protection</u>: when the load(LED Chips series connection)too small or the battery voltage is too high,When the load current into the runaway state and current exceeds the maximum set power,will start the overload protection function.</p>
	<p><u>Over Charge Projection</u>: When charging the battery voltage is too high,the controller will automatically disconnect the charging circuit , in order to avoid damage to the battery .</p>

	<p><u>Over Discharge protection</u> : When battery voltage discharge too low , controller will cut off the load output automatically to protect battery.</p>
	<p><u>PV modules reverse polarity protection</u>:When PV modules reverse polarity(NOT suggested), the controller will not damage,will continue to work after the correction of wiring errors.</p>
	<p><u>Battery polarity protection</u> : When battery reverse polarity(NOT suggested), the controller will not damage,will continue to work after the correction of wiring errors.</p>
	<p><u>Temperature sensor damage fault protection</u>: When the temperature sensor short circuit or damage , the controller will default working at 25 °C. In order to avoid battery errors and damage caused by "broken" temperature compensation.</p>
	<p><u>Trickle charging protection</u>:When PV module charge the battery,when battery voltage reach peak voltage, if continue to charge battery with high voltage,battery will be likely to cause dehydration or loss of control;if stop charging the battery then can not be saturated.But with this controller,when battery reached peak voltage,it will buck 1V immediately,then enter the trickle charge state,Ensure that the battery can be stabilized in full state , while avoiding dehydration or loss of control ,Similar to a battery charge cycle , not only efficiently protects the battery , but also enhance the battery charging times and longer life.</p>

Instructions

2.1 Panel Introduction

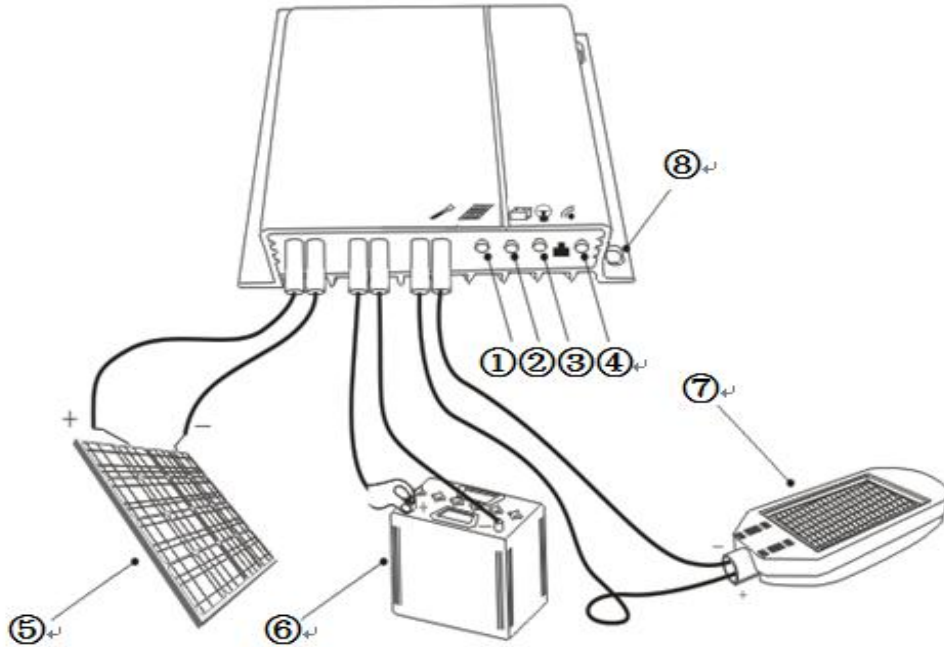

- ① PV indicator (green)
- ② Battery indicator (red/green)
- ③ Load indicator (yellow)
- ④ IR communication connector
- ⑤ PV connection terminal
- ⑥ Battery connection terminal
- ⑦ Load connection terminal
- ⑧ Installation hole

2.2 LED Indicators

A, PV Indicator

Color	Indication	Working State
Green	On Solid	PV is charging Battery
Green	Flash Fast	Battery Over Voltage, refer to Trouble shooting.
---	OFF	PV voltage is low

B, Battery Indicator

Color	Indication	Working State
Green	On Solid	Battery is Normal
Green	Flash	Battery is full
Yellow	On Solid	Battery is under voltage
Red	On Solid	Battery is over-discharged, turn off Load auto

C, Load Indicator

Color	Indication	Working State
Yellow	On Solid	Load is ON
--	OFF	Load is off
Yellow	Flash Fast	Load short circuit or open circuit
Yellow	Flast Slow	Load string number is too low Or overload limited power output

2.3 Charge Description

The controller utilizes Maximum Power Point Tracking technology to extract maximum power from the solar module (s). The tracking algorithm is fully automatic and does not require user adjustment, MPPT technology will track the array maximum power point voltage (V_{mp}) as it varies with weather conditions, ensuring that maximum power is harvested from the array through the course of the day.

Current VS. Voltage in 12V system

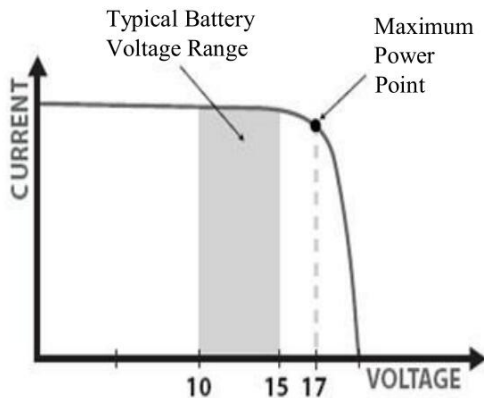

Output power in 12V system

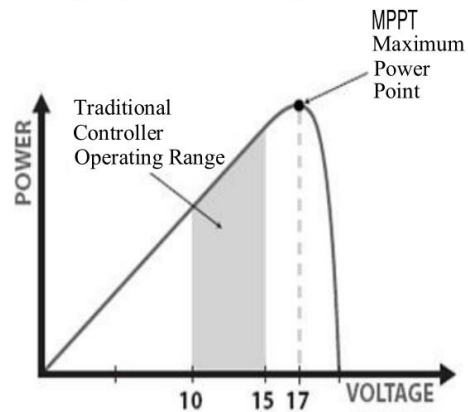

Fast Charge Stage

When battery voltage has not yet reached full voltage setting value, will be a fast charge, the controller will provide 100% of the available solar energy for the battery charge.

Boost Charge Stage

When the battery has recharged to the Boost voltage setpoint, constant-voltage regulation is used to prevent heating and excessive battery gassing. The Boost stage remains 60 minutes and then goes to Float Charge. Every time when the controller is powered on, if it detects neither over discharged nor overvoltage, the charging will enter into boost charging stage.

Direct Charge Stage

Keep the battery in the direct charging stage of the accumulative time of 120 minutes, and then transferred to the floating charge stage.

Automatically enter the charge stage of each battery when the system

detects.

Float Charge Stage

After the Boost voltage stage,SDW-M will reduce the battery voltage to Float voltage set point. When the battery is fully recharged, there will be no more chemical reactions and all the charge current transmits into heat and gas at this time. Then the

SDW-M reduces the voltage to the floating stage, charging with a smaller voltage and current. It will reduce the temperature of battery and prevent the gassing, also charging the battery slightly at the same time.

The purpose of Float stage is to off set the power

consumption caused by self consumption and small loads in the whole system, while maintaining full battery storage capacity.

In Float stage, loads can continue to draw power from the battery. In the event that the system load(s) exceed the solar charge current, the controller will no longer be able to maintain the battery at the Float set point. If the battery voltage remains below the boost charge reconnecting voltage, it will stop float charge stage and return to direct charge stage.

Lithium Battery Charge

Control the charging process by detecting the charge voltage and current value. After the completion of the charge off the charger, so as to ensure the safety of the battery charge. On the lithium battery charging can be

divided into three stages: constant current charging, constant voltage charging, charging termination.

A, Constant current charging

when the battery voltage is increased to trickle charge above threshold and increase the charging current constant current charging. Usually the current constant current charge should be set between 0.2C and 1.0C. Battery voltage gradually increases with constant current charging process.

B, Constant voltage charging

when battery voltage to rise to the charging set voltage constant current charging end, constant voltage charging stage. Current according to the saturation of the core, with the charging process continue to charge current by the maximum value of the maximum. Usually charge set voltage for single string 4.2V specific should be based on the battery manufacturers to provide the parameters and set, (C is a battery nominal capacity of the control current of a method, such as the battery is the capacity of 1C, 1000mAh is the charge current 1000mA.)

C, Charge termination

Monitors the charging current of the constant voltage charging phase and terminates the charge when the charge current is reduced to the charge termination current. Usually 0.02C to 0.07C.

2.4 Discharge Description

(1) Discharge operation mode:

The controller can run automatically and unattended by following a preset mode. The controller provides four operation modes:

- Light-control mode: when dark, the solar panel voltage will drop to the start point. After a predefined delay time, the controller confirms the startup signals to switch on the load for operation; At dawn, after the light intensity has risen above the start point and a predefined delay time has elapsed, the controller confirms the shutdown signals to switch off output, and the load will stop operation.

- Testing mode: This mode is used for system testing. It's almost the same as complete light-control mode. The only difference is elimination of the delay time before optical signal determination, and all other functions are preserved to facilitate checking of proper system functions during installation and testing.

- Manual mode: In this mode, the output on load side is switched on or off manually. Switching operations are performed by pressing the function key(F1) on the remote controller.

- Automatic mode: This mode provides both light-control and timer functions. In the absence of sunlight, the light intensity will drop to the start point. After a predefined delay time, the controller will confirm the start signals and the load will be switched on. At this point, the timing sequence starts. When the total time reaches the sum of time settings for the first to five periods, the load will be switched off. Before dawn, the controller restarts this six-period, and the load is switched on till day break. As the daily sunshine time varies with season, the specific time settings for the six periods also change to keep ahead of day break.

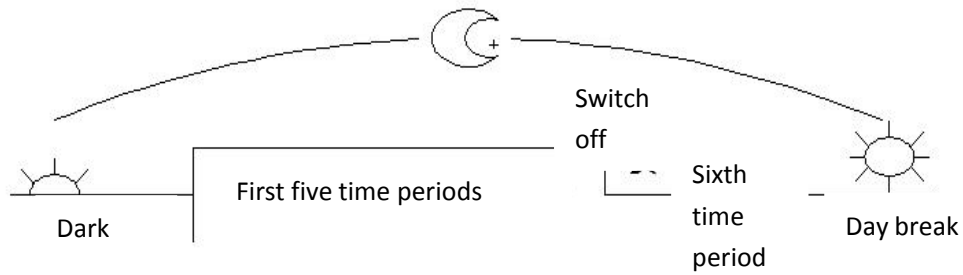

Figure 2.4 Automatic mode diagram

In automatic mode, the output current depend on current setting of the different period. In other modes, the output current depend on current setting of the first time period.

Installation

3.1 Fix the controller

Fix the controller at a place free of direct sunlight, high temperature, and immersion risks. Take care of the radiator under the device, which is used to decrease device temperature during full-power operation. Measures should be taken to avoid obstruction and to ensure heat dissipation through natural convection. For installations in confined space such as lamp post, the radiator ribs should be preferably oriented along the air flow direction.

3.2 Connection method

A connection method commonly used by electricians is recommended below. Please connect each wire of the controller according to standard procedures.

- All delivered wires for the controller have reserved cuts, which facilitate easy stripping during connection while preventing short circuit

due to contact between wires. Please follow the steps below during installation and avoid removing insulation of all six wires at one time.

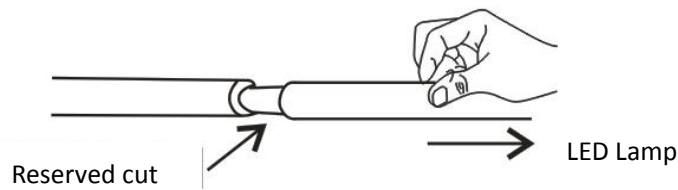

Figure 3.2 First step during wiring – wire stripping

- Cross the copper wires in the controller lead and load lead, and then twist them around the rear section of each other and tighten them. This wiring method provides a large contact area and a high connection force, thus ensuring long-time reliable connection. The connectors should be tightened as well. The wires should be preferably fixed with cable ties to prevent loosening of connectors during wire vibration in mobile applications.

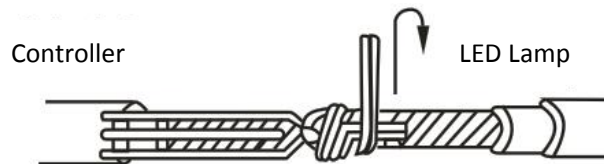

Figure 3.2.1 Second step during wiring - connection

- Use waterproof insulation tapes to wrap around exposed parts of wires. To ensure their reliability, high-pressure rubber self-adhesive tapes can be used as the inner wrapping layer and electrical tapes as outer layer. Measures should be taken to prevent aging and falling of the electrical tapes and consequent short-circuit accidents due to long-time use in humid and hot environments.



Figure 3.2.2 Third step during wiring – wrapping of insulation layers

Standard wiring is critical for long-time reliable system operations. Loose or unstable wire connections may lead to excessive resistance and consequent heating at connection parts. In these occasions, the wire insulations tend to experience premature aging, which will in turn lead to short circuit, open circuit, and other failures.

3.3 Connection Step

For the sake of safety, please complete wiring in the following order:

①load, ② battery, ③pv

- Load connection: As the controller has not started operation, there is no response from the controller after load connection.

- Battery connection: Before connection of the battery, make sure that the battery voltage is higher than 9V so that the controller can be started. For a 24V system, make sure that the battery voltage is not lower than 18V. After completion of battery connection, the controller will start to work. 10s later, the load will be light up automatically to confirm correct wiring.

- Solar panel connection: The controller can be used for both standard 12V or 24V solar panel components and those with an open-circuit input voltage not exceeding the specified maximum input voltage. The voltage at the highest power point of solar components should not be lower than the battery voltage.

Trouble Shooting

Phenomenon	Analysis	Solutions
<ul style="list-style-type: none"> ·In daytime,PV indicator is dark ·In daytime,Load is on ·Load work only for the one whole night 	<ul style="list-style-type: none"> ·solar panel cables Connection mistake. 	<ul style="list-style-type: none"> ·check solar panel cables connection is correct or not. ·cut off the solar panel cables connection with solarcontroller, check the volage of VOC,then reconnect.
<ul style="list-style-type: none"> ·Load Indicator flash fast & LED lamp not work. 	<ul style="list-style-type: none"> ·LED lamp cable is open circuit or short circuit. ·LED lamp is broken 	<ul style="list-style-type: none"> ·recheck the LED lamp cables connection is correct or not. ·cut off LED lamp connection cables,then reconnect.
<ul style="list-style-type: none"> ·Load Indicator flash slowly 	<ul style="list-style-type: none"> ·Output power over the controller rated power 	<ul style="list-style-type: none"> ·Low down the output current
<ul style="list-style-type: none"> ·Battery indicator is red ·LED turn on for a short time。 	<ul style="list-style-type: none"> ·Battery voltage is low。 ·Cables resistance is too big or the battery is damaged 	<ul style="list-style-type: none"> ·If this occurs often,then need to check PV charging Whether normal ,solar panel is blocked or not,or other reasons caused PV not charge normally. ·Battery quality is good or not. ·Check the battery cables is too long or if there is any connection not good to battery.

IR Remote Control

5.1 Diagram

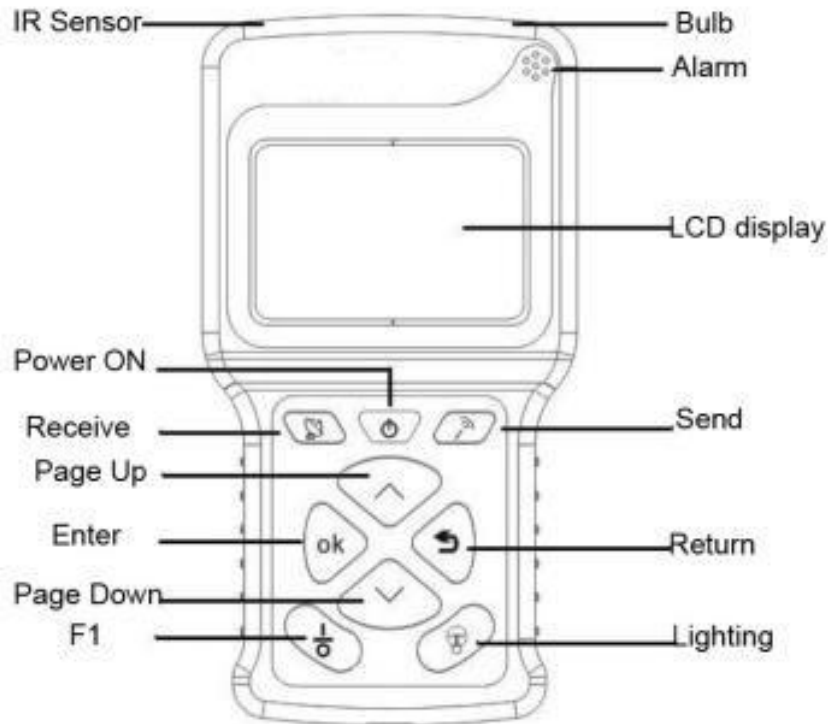

5.2 Operation of remote control

Power ON/OFF

Press “Power” button continue for 3 seconds to start up the remote control,for power off,just leave the remote control without any operations for 5minutes,then it will be power off automatically.Or you can press “Lighting”button continue for 3 seconds for Power OFF.

LCD Screen Display after Power ON

1.Setting

Parameters setting for all the models of controllers,including battery specification and other charge and discharge parameters,also you can set the work mode of output here.

2 .Real-Time Data

Real-time data for all the controllers that is working now,all the value on the LCD screen display is real-time.

3. System Setting

Remote control system setting,Including Remote Style,Language, Alarm,Factory Reset and Edition.

Receive and Send Signal to controller

RC-3 Remote control transfer signal by infrared,the distance indoor can be 10-15m,and outdoor will be shorter for environment difference.

Press “Receive” button to get the signal from working controller,you can know what kind of work mode is saved inside of controller.you can page up and down to check all the parameters of working controller.

After set all the parameters well,and make the remote control face to the controller that need to be set,press “Send” button,controller will receive the signal from remote control,after recheck inside controller with no problem,3 indicators on the controller will flash all together for

one time,meaning that sending signal successfully.the same time,some controllers will send back the successful signal to the remote control again,after remote control get the signal,alarm will work for reminding.

(Attention:sometimes remote control will not get signal from controller,and LCD screen will show “communication over time”,and remote control will make sound “DI DI DI”for 3 times,reasons are that the distance is too far,the angle not correct or occlusion of some other object between remote control and controller).

Lighting

After Power ON the remote control,you can press “lighting”button for lighting in the night,press one more time again for off.

Parameter changing

When enter into the setting mode,press “O.K”button to change the value of each parameter,when it flash,meaning enter into the editable status,you can change the parameter by press page up or down button,after set well,press “O.K”button to save the value.the same time,the parameter will stop flashing,and you can press “Return” button to be back to previous menu.

(if the parameter is flashing,and you press “return”button,the data will not be saved)

5.3 Introduction for different controller models

This type remote control fit for all our products that support IR function,like solar charge controller,solar controller inbuilt LED driver,grid solar hybrid controller,LED driver, etc.the parameters of each controller is different,please set the value according to the controller that you installed.once you set the parameters over the range of the controllers,the controller will not receive the signal from remote control,you can reference to the chart in the following:

Controller Type	Corresponding model	
Solar Controller built in LED Driver	SDW series、SDW-M series	
Solar Charge Controller	SDW-P series、SDW-MP series	
Solar Utility hybrid controller	SDH series.SDH-P series	
Parameter settings		
Item	Parameter setting range	Remark
1st period working time(Hours)	00: 00~09:50	
1st period working power(Current)	0mA-8000mA	
2nd period working Hour(Hours)	00: 00~09:50	
2nd period working power(current)	0mA-8000mA	
3rd period working time(Hours)	00: 00~09:50	
3rd period working power(current)	0mA-8000mA	
4th period working time(Hours)	00: 00~09:50	

4th period working power(current)	0mA-8000mA	
5th period working time(Hours)	00: 00~09:50	
5th period working power(current)	0mA-8000mA	
Morning Period Time(Hours)	00: 00~09:50	
Morning Period Time power(current)	0mA-8000mA	
Work mode	Manual/auto/testing/light control	
Smart Control	Off/M1/M2/M3/M4/M5/M6	
Note: Difference of M1-M6 refer to 7.0 Appendix.		
Set charge	ON/OFF	
If "Set charge" is off, the following items will not be shown on the remote while program		
Light control delay time	20s or 2~60min.	
Light control voltage	3.5~10V	
Battery type	Lead-acid / Gel/ Lithium/custom	
System voltage	12v or 24v	Only For Lithium Battery type setting
Over voltage	15.0~20.0V	
Over discharge	8.0~20.0V	
Over discharge return voltage	10~20.0V	
charge voltage	10.0V~20.0V	
Charge Current	0.1A-20A	
Charge End Current	0.1A-20A	

Charge Temperature		Only For Custom Battery type setting
Discharge Temperature		
Over voltage	15-20v	
Over discharge	8.0~20.0V	
Over discharge return voltage	10~20.0V	
Boost Charge	10~20.0V	
Float Charge	10~20.0V	

5.4 Real-Time Data

After enter into this mode,remote control will receive the signal from working controller automatically,and display the working status and specification of PV,battery,load,total capacity charged and discharged,temperature etc.Only make sure that the communication is reliable and effective.

5.5 System Setting

1,Remote Style

Brief:set parts of main parameter of controller easily.

Standard:set all the parameter in this mode.

For remote style changing,you can use with page up and down,or you can press “F1”button continue for 3 seconds.

2,Language

Chinese/English for changing

3, Alarm

You can turn ON/OFF sound of remote for reminding.

4 ,Factory Reset

One button to make factory reset if you have any problem during application.

5, Edition

The edition of remote control

5.6 Additional function

This remote control support the locking function,you can press “F1”+”Lighting” buttons together to lock/unlock the remote,after lock the remote,you can only send the signal to controller or receive the signal from controller,all the parameters of remote can’t be programming in lock status.this function to avoid the workers to change the parameters by mistake.

5.7 Appendix

1, Work mode:Manual,Auto,L-Ctrl,Testing

Manual:turn ON/OFF the load by pressing “F1”button.

Auto:light control+timer,work for all time periods.

L-Ctrl:the load will work during sun set and sun rise,work the whole night.

Testing:testing for system without any time delay after sunset.

2,Smart mode(Only work for type of controller built in led driver)

Including smart energy-saving mode (modes 1 to 4) and external motion sensor mode (modes 5 and 6). In smart energy-saving mode, automatic power reduction control is provided based on current battery charge and ambient temperature variations to prevent over discharging and improve battery service life. This mode is ideal for different series of solar control constant-current integrated machines. The power reduction amount is given below. The specific settings should be made according to actual needs.

For (M5,M6),this work mode is for motion sensor for human being and radar to adjust the output for LED lamp auto,for M5,when nobody nearby,the output current lower to 150mA,for M6,when nobody nearby,the output is 0(Lamp is off),when human being comes nearby,output current will boost to the setting value to turn on the LED lamp.

Note:this function need special controller with external sensor.

Warranty

Warranty Card

Product Name _____

Product Model _____

Serial number _____

Date of purchase: ____Date____Month____Year

Company Name: _____

Contact: _____

Address: _____

Tel: _____

1. The product warranty period is three years since factory.
2. During the warranty period, any problem caused by normal use under the user manual (determined by the controller factory), reparation is free of charge.